

## Project Narrative

# Experimental Medium Energy Physics at Arizona State University

September 2021

Project Title: Experimental Medium Energy Physics at Arizona State University  
Organization: Arizona State University, College of Integrated Sciences and Arts  
7271 E. Sonoran Arroyo Mall, Mesa, AZ 85212-6415

Principal Investigator: Michael R. Dugger [(480) 965-0728, [dugger@jlab.org](mailto:dugger@jlab.org)]

ASU Admin. Contact: Katrina Smith [(480) 965-4225, [Katrina.Smith@asu.edu](mailto:Katrina.Smith@asu.edu)]

Submitted to: Department of Energy, Office of Nuclear Physics  
Funding Opportunity: DE-FOA-0001820  
DOE Contact: Gulshan Rai  
Research Area: Medium Energy  
New Grant Period: 9/1/2022 - 9/1/2025

# Contents

<b>1</b>	<b>Introduction</b>	<b>1</b>
<b>2</b>	<b>Research to be undertaken under proposed award</b>	<b>3</b>
2.1	The CLAS12 detector . . . . .	3
2.2	The GlueX detector in Hall D . . . . .	4
2.2.1	TPOL: The ASU triplet polarimeter . . . . .	5
2.3	Probing the $\Xi$ baryon spectra . . . . .	6
2.4	Exotic hadrons . . . . .	6
2.5	Past accomplishments and works in progress . . . . .	8
2.5.1	Work on $K^* \bar{K}$ states . . . . .	9
2.5.2	Work on $\Xi^*$ states . . . . .	11
2.6	Publications during the current grant . . . . .	12
<b>3</b>	<b>Research plan</b>	<b>13</b>
<b>4</b>	<b>Impact of other work on this grant's resources</b>	<b>13</b>
<b>5</b>	<b>Human resource development</b>	<b>13</b>
<b>6</b>	<b>Requested resources and justification</b>	<b>14</b>
6.1	Senior personnel . . . . .	14
6.2	Other Personnel . . . . .	14
6.2.1	Graduate Research Associates . . . . .	14
6.3	Fringe benefits. . . . .	14
6.4	Total salaries, wages and fringe benefits . . . . .	15
6.5	Equipment . . . . .	15
6.6	Travel . . . . .	15
6.7	Other direct costs . . . . .	16
6.8	Total direct costs . . . . .	16
6.9	Indirect costs . . . . .	16
6.10	Total Direct and Indirect costs . . . . .	16
<b>7</b>	<b>Institutional support</b>	<b>16</b>
<b>8</b>	<b>Summary of meaningful metrics</b>	<b>16</b>
	Appendices	18
<b>A</b>	<b>Bibliography and references cited</b>	<b>18</b>
<b>B</b>	<b>Data management plan</b>	<b>21</b>

<b>C</b>	<b>Principal collaborators</b>	<b>22</b>
C.1	Close collaborators . . . . .	22
C.2	Advisors and postdoctoral sponsors of the primary investigator . . . . .	23
C.3	Former post-doctoral participants in academic and lab positions . . . . .	23
C.4	Former Ph.D. students in academic and lab positions . . . . .	23
<b>D</b>	<b>Publications</b>	<b>23</b>
<b>E</b>	<b>Biographical sketches</b>	<b>24</b>
E.1	Michael R. Dugger . . . . .	24
<b>F</b>	<b>Student tracking information</b>	<b>26</b>
<b>G</b>	<b>Current and pending support</b>	<b>26</b>
<b>H</b>	<b>Facilities and resources</b>	<b>26</b>
H.1	Laboratory facilities . . . . .	26
H.2	Computer facilities . . . . .	26
H.3	Office space . . . . .	26
H.4	Major instrumentation . . . . .	27

# Abstract

Using the experimental facilities of Jefferson Lab in Halls B and D, the Arizona State University (ASU) Meson Physics Group will conduct experiments to search for and characterize (1) excited baryons containing two or more strange quarks and (2) hybrid meson states that have  $K^+K^-\pi^0$  decay products. Both types of particles have been specifically predicted by hadron models based on quantum chromodynamics (QCD), exploiting flavor symmetry and gluonic excitations. The detailed knowledge of the spectrum of these states that will be obtained is essential for meeting the goals of Nuclear Science Advisory Committee (NSAC) Long-Range Plan.

## 1 Introduction

The ASU Meson Physics Group is primarily interested in determining the existence and properties of hadronic resonance states. I have chosen to focus our efforts on resonance states that involve strangeness. In particular, we have concentrated on the excited  $\Xi$  baryons and the meson resonances that decay  $KK\pi$ .

As stated in the current NSAC Long-Range Plan [1]: “[t]he new capabilities of the 12-GeV era facilitate a detailed study of baryons containing two and three strange quarks. Knowledge of the spectrum of these states will further enhance our understanding of the manifestation of QCD in the three-quark arena.” It is our goal to provide the detailed data regarding the excited  $\Xi$  baryons.

Improving our understanding of quark confinement in hadrons requires deepening our insight into the gluonic fields within those particles. Exploration of the spectrum and properties of exotic hybrid mesons has emerged as a key path forward for exploring quark confinement. Indeed, that topic was a major motivation for the upgrade of JLab, and is specifically mentioned multiple times in the NSAC Long-Range Plan [1].

For our study of mesonic resonances, the primary focus is to assist in fully mapping out the light meson nonets while pushing upwards in mass towards potential discoveries of exotic hybrid meson states that decay  $K^*\bar{K}$ . The presence of non-standard  $J^{PC}$  quantum numbers would be sufficient to clearly identify a meson as being “exotic”. To assist in the  $J^{PC}$  determination, the degree of photon polarization is very useful. The knowledge of the degree of photon polarization is required for determining beam asymmetries, which in turn, help establish the parity quantum number  $P$ .

The ASU Meson Physics Group successfully proposed, designed, built, and now operates a first-of-its-kind triplet-photoproduction photon-polarimeter (TPOL) to measure the degree of linear polarization of the Hall D photon beam. The group will remain responsible for determining the polarization of the photon beam for all experiments in Hall D.

During the current award period, undergraduate research has been utilized to good effect. The undergraduate participants Patrick Walker, Rebecca Osar and Emily Lamagna worked on CLAS12 data. Mr. Walker presented his work on analyzing  $K^+K^-$  states at the College of Integrative Sciences and Arts (CISA) Student Research Day [2] and presented an analysis  $K^*K$  final states at the ASU Undergraduate Physics Symposium [3], successfully defended his honors thesis, graduated with his B.S degree and won the ASU Department of Physics Research Award. Ms. Osar presented results from her event generator at the CISA

Student Research Day [4] and her results of  $K\Lambda^*$  states electroproduced from the proton at the ASU Undergraduate Physics Symposium [5]. Ms. Lamagna is in the process of analyzing the reaction  $ep \rightarrow ep\phi\pi$  and showed her work at the ASU Undergraduate Physics Symposium [6]. Additionally, undergraduate student Anna Costelle won the ASU Women in Physics Award for Undergraduate Research for her presentation describing the development of an event generator for strangeness states [7]. In May of 2020, undergraduate student Mohamed Mohamed won the CISA Undergraduate Research Award for his work on energy deposition studies using the Monte Carlo simulation software GEANT4 [8] and for a study on the use of decision trees to assist in particle identification [9]. Undergraduate student Kevin Scheuer presented his study of machine learning methods for  $K\pi$  at the spring 2020 CISA research symposium [10].

While we are very proud of our undergraduates, the primary focus of our work is accomplished by our graduate students. Graduate student Sebastian Cole (now Dr. Cole) successfully defended his dissertation that was based on studies utilizing AmpTools (partial wave analysis software) to find the  $J = 0$ ,  $J = 1$  and  $J = 2$  contributions to the mass spectrum of  $K^* K$  states in the mass region below 1.6 GeV. Sebastian won the CISA outstanding graduate student award in December of 2020. Graduate student Brandon Sumner has refined his preliminary cross sections for  $\gamma p \rightarrow K^+ K^+ \Xi^-(1530)$ , where  $\Xi^-(1530) \rightarrow \Xi^- \pi^0$ . Brandon has also begun analyzing data for excited cascades to decay  $\Xi^0 \pi^-$  as well as to  $K^- \Lambda$ . Graduate student Alan Gardner just finished his first year and assisted Sebastian Cole in building code used in the partial wave analysis of the  $K^* K$  from GlueX data. Prior to his graduate studies, Alan conducted a preliminary search for the  $\Xi^-$  baryon using CLAS12 data.

The Primary Investigator (PI) performed studies of systematics of the polarization measurement from the ASU triplet polarimeter associated with the converter thickness, performed final-stage analysis of polarimeter data for the 2020 data set (ongoing) and assisted students in analysis projects related to GlueX and CLAS12 data.

This proposal seeks support for a program of measurements that will provide improvements in our knowledge of hadron spectroscopy, focused on activities at Jefferson Lab (JLab) (1) within Hall B using the CEBAF Large Acceptance Spectrometer (CLAS) newly upgraded for experiments using the 12 GeV beam at JLab (CLAS12) and (2) within Hall D using the GlueX detector.

We will obtain and analyze data using the GlueX and CLAS12 detectors to explore the spectrum of multi-strange-quark baryons in order to assist in resolving the missing resonance problem for  $\Xi$  states and to refine our knowledge of the excited  $\Xi$  properties. We will also map out the light mesons that decay  $KK\pi$  with a particular interest in finding meson resonances that exhibit exotic  $J^{PC}$  quantum numbers.

Currently, the ASU Meson Physics Group is comprised of the principal investigator Associate Professor Michael Dugger, Graduate Research Assistant Brandon Sumner, Graduate Research Assistant Alan Gardner, senior undergraduate student Shane Watters, senior undergraduate student Emily Lamagna and junior undergraduate student Rebecca Osar. The proposal seeks funding for supporting the principal investigator (PI), two graduate students and to assist in undergraduate participation in remote meetings.

## 2 Research to be undertaken under proposed award

Prior to any analysis performed to uncover hadronic states within physical data, that data must be acquired using specially designed, built and operated detector systems. I provide a brief overview of those detector systems used in measuring the data that are to be further analyzed.

### 2.1 The CLAS12 detector

While the CLAS12 detector is designed primarily to measure deeply exclusive scattering using electron beams, a forward tagger has been installed within CLAS12 that enables quasi-real photon experiments with  $q^2$  as low as  $0.01 \text{ GeV}^2$ . The ASU efforts in Hall B make use of this forward tagger to perform photoproduction measurements from the cryogenic hydrogen target within the CLAS12 detector.

As seen in Fig. 1, CLAS12 is composed of two main detector arrays: the Central Detector (CD) and the Forward Detector (FD). The FD covers the range of  $5^\circ$  to  $40^\circ$  in polar angle, whereas the CD covers the polar angles from  $40^\circ$  to  $135^\circ$ . The FD provides separation of identified  $K^\pm$  and  $\pi^\pm$  having momenta less than  $3 \text{ GeV}/c$ , and separation of protons and  $K^\pm$  with momenta less than  $4.5 \text{ GeV}/c$ .

A cryogenic target cell is located at the center of the cylindrically-symmetric CD. Surrounding the cryogenic target cell is a Silicon Vertex Tracker (SVT) yielding  $1 \text{ mrad}$  angular resolution in azimuthal angle and  $15 \text{ mrad}$  in polar angle for charged tracks, as well as providing vertex resolution better than  $2 \text{ mm}$ . Outside the SVT is the cylindrically-symmetric Central Time-of-Flight system (CTOF). The CTOF scintillator array has a timing resolution of  $50 \text{ ps}$ . The Central Electromagnetic Calorimeter forms the next cylindrical layer, consisting of a scintillating-fiber/tungsten-powder array. These detectors are housed within a  $5\text{-T}$  superconducting solenoid magnet of aperture  $0.78 \text{ m}$ . The original CLAS superconducting toroidal magnet has been repurposed for CLAS12, with the same six-sector azimuthal symmetry as the original detector.

Downstream of the SVT are the High Threshold Cherenkov Counters and the Forward Tagger (FT) arrays. Electrons that scatter with angles between  $2.5^\circ$  and  $4.5^\circ$  are detected in the FT, enabling quasi-real photon experiments such as those we will undertake in this work. Beyond the FT are three regions of drift chambers, forming the Forward Tracking Chamber (FTC). The chambers are arranged in a fashion similar to the original CLAS design, with Region 1 drift chambers located before the torus magnet, Region 2 within the torus magnet, and Region 3 behind the torus. Ultimately, the spatial resolution for this chamber package is expected to be a factor of 3 better than the original CLAS system. Downstream of the FTC are the Low Threshold Cherenkov Counters (LTCC), which are modified versions of the original CLAS Cherenkov counters with the same external geometry. As with the LTCC, the Forward Time-of-Flight (FTOF) system has the

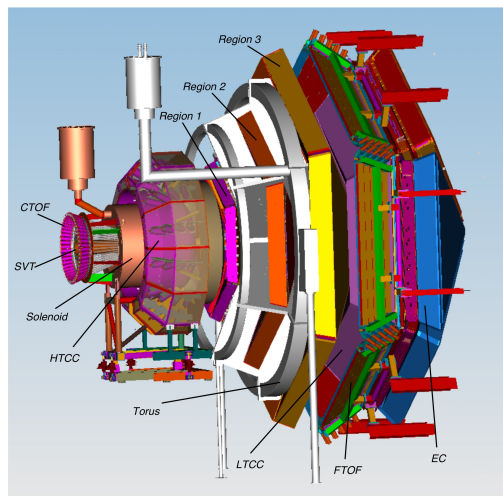

Figure 1: Schematic diagram for CLAS12. The labeled subsystems are described in the text.

same geometry as the original CLAS system, but has been upgraded to obtain 80-ps timing resolution. The detector furthest downstream is the Forward Electromagnetic Calorimeter, an array retained and repurposed from the original CLAS detector.

## 2.2 The GlueX detector in Hall D

The Hall D GlueX detector was built to search for gluonic excitations within mesons with masses up to 2.5 GeV [11, 12]. Distinguishing states with gluonic excitations from other meson states will require the determination of exotic quantum numbers,  $J^{PC}$  that are unlike the assignments possible with traditional constituent quark models of meson states. A full partial wave analysis will be needed to obtain  $J^{PC}$  for the observed states. To minimize possible ambiguities in obtaining the required  $J^{PC}$  information from the partial wave analysis, all decay products from the candidate hybrid meson must be identified with good resolution. The identification of all decay products is greatly enhanced when the detector has a full acceptance in decay angles. For these reasons the GlueX detector (Fig. 2) was designed to have  $4\pi$  solid angle coverage, with nearly full hermeticity, and good momentum and energy resolution of photons and charged particles.

Electrons with energies of 12 GeV incident on a thin (50 or 20  $\mu\text{m}$ ) diamond radiator produce a beam of linearly polarized photons ( $\approx 40\%$  polarization) with  $E_\gamma = 8.5\text{--}9$  GeV. The tagging of the post-bremsstrahlung electron determine the photon energy to within 0.1%. The photons strike a 30-cm-long liquid hydrogen target surrounded by a start counter. Past the start counter, the next detector elements are cylindrical drift-chambers, which are surrounded by a cylindrical electromagnetic calorimeter made of lead and scintillating fibers. The target, start counter, drift chambers, and electromagnetic calorimeters are all contained within a refurbished 2.25 T superconducting solenoid that provides the momentum-analyzing magnetic field. On the downstream side of the solenoid is a time-of-flight system and a 3000-element lead-glass electromagnetic calorimeter. For 9 GeV incident photons, the GlueX detector has  $4\pi$  acceptance for photons and charged particles to facilitate the partial-wave analyses of many-particle final states. The acceptance of final-state particles is typically better than 95%, and is very uniform over the detector. Moreover, the near hermetic design of the detector is well suited for determining the masses and  $J^{PC}$  for mesons with masses from 1.5 to 2.5  $\text{GeV}/c^2$ .

For increased precision in kaon particle identification, the newly acquired DIRC (Detection of Internally Reflected Cherenkov) is placed just in front of the FCAL. The DIRC has as the main component four boxes filled with fused silica bars from the BaBar experiment. When installed in the BaBar experiment, these boxes provided good kaon separation up to 4 GeV [13]. Similar performance is expected when utilized for the GlueX experiment, greatly

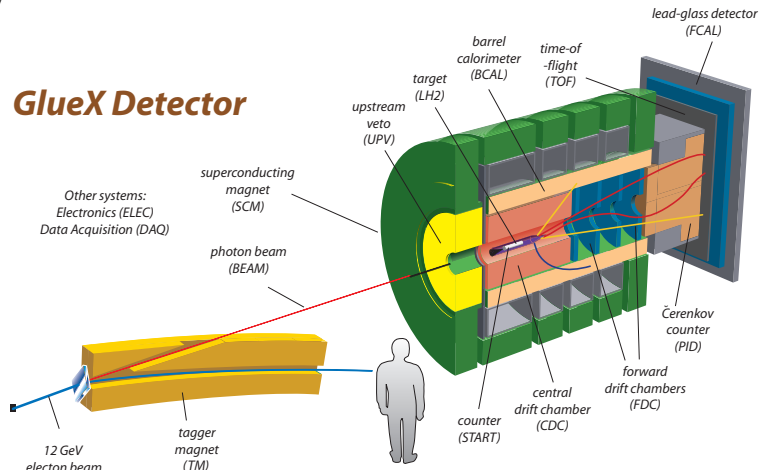

Figure 2: Diagram of Hall D and the GlueX detector.

improving kaon identification, which will facilitate many analyses including those ASU is particularly targeting.

### 2.2.1 TPOL: The ASU triplet polarimeter

The partial-wave analyses to be undertaken in the GlueX search for hybrid mesons require an absolute uncertainty of  $\pm 0.04$  in the photon beam polarization. In order to obtain that goal, the ASU Meson Physics Group designed and constructed a detector system (called TPOL) that measures photon beam asymmetries with this triplet production process (pair production off a recoiling atomic electron), and installed the system in the Hall D beamline.



Figure 3: Interior of TPOL vacuum chamber with SSD and production target ladder assembly (from beam left).

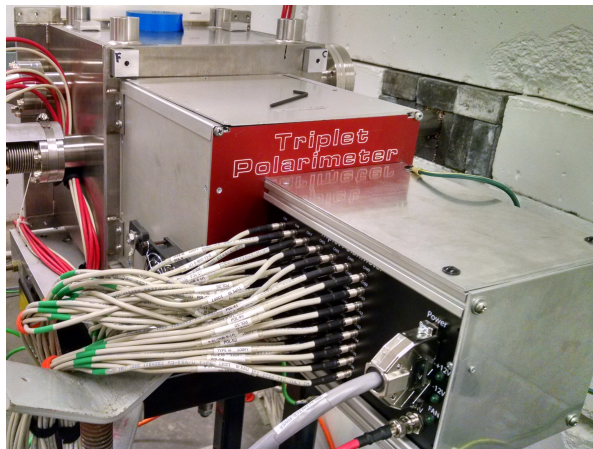

Figure 4: TPOL vacuum chamber and electronics housings installed in Hall D beamline (from beam right).

TPOL uses a double-sided silicon strip detector (SSD) manufactured by Micron Semiconductor to measure timing, energy deposition, and the azimuthal distribution of recoil electrons coming from the triplet production process. Fig. 3 shows the interior of the TPOL vacuum chamber; the beam transits that figure from right to left. The SSD has 32 azimuthal sectors on the ohmic side and 24 concentric rings on the junction side, with an outer active diameter of 70 mm and an inner active diameter of 22 mm.

The TPOL installation in the Hall D beamline is shown in Fig. 4, seen from beam right. The housings consist of three boxes attached to one another. The largest rearmost box in the figure is the vacuum chamber, the middle box is the preamp enclosure, and the smallest box is the distribution box that routes voltages and signals to and from the preamps. Cables attached to the distribution box include the signal lines (white), high voltage bias (red) and low voltage (gray) lines.

To determine the degree of photon beam polarization  $P$  in practice, the value of  $B$  obtained from fitting the azimuthal distribution to  $A [1 + B \cos(2\phi)]$  is divided by the analyzing power  $\Sigma$ .

ASU is positioned to continue providing the important polarization information for all Hall D experiments with TPOL during the proposed award period.



## 2.3 Probing the $\Xi$ baryon spectra

Studies of two and three-strange-quark baryons have great potential to enhance our understanding of the QCD structure within baryons. The “computational cost” for predictions using lattice QCD are greatly influenced by the number of light quarks ( $u$  and  $d$ ) present in the baryon studied. For that reason, studies that extend our knowledge of the properties of states with two strange quarks should be extremely useful in deepening insight into how all baryons are assembled from quarks.

The ASU group is participating in experiments which will provide the largest-ever sample of photoproduced cascade  $\Xi$  baryons. Using the CLAS12 and GlueX detectors, our measurements should greatly enhance knowledge of the excitations of these baryons, which in turn will provide an empirical “proving ground” for QCD-based descriptions of baryons with varying numbers of heavy quarks.

While the “missing resonance” problem for the nucleon system is much discussed, the missing resonance problem is even more striking when looking at the  $\Xi$  sector. For example, the Isgur and Capstick relativistic constituent quark model [15] predicts 44  $\Xi$  states with masses below 2.5 GeV, yet the PDG [14] only lists *six* cascade resonances with ratings of three or four stars, as indicated in Table 1.

Looking more closely at the  $\Xi$  states, photoproduction cross sections for  $\Xi$  resonance states are observed to be much smaller than for nucleon resonances. However, the widths of the  $\Xi$  excitations are much narrower than those for the nucleon, which should make them easier to identify [16]. As seen in Table 1, the well-known cascade resonances also have mass separations that are greater than the resonance widths, which again should make identification of excited  $\Xi$  states far easier than for the  $N^*$  and  $\Delta$  states (with widths of  $\sim 150$  MeV). Even with those advantages, however, no new cascade states have been discovered in the last 20 years. The large solid angle of the CLAS12 and GlueX detectors permit using exclusive reactions to markedly reduce backgrounds. Moreover, the detectors simultaneously measure  $\Xi^*$  decay modes, allowing for the determination of branching ratios that are, as shown in Table 2, not well determined for most of the three and four star  $\Xi^*$  states [14]. Of particular interest is the apparent suppression of the excited cascades going to  $\Xi\pi$ . For the  $\Xi(1530)$ , the branch to  $\Xi\pi$  is given in the PDG as 100%, but for all other cascades, the observed decay branches are merely characterized as “small” or “seen”. Measuring the  $\Xi^*$  branching ratios for states that decouple from  $\Xi\pi$  can help shed light on why the  $\Xi^*$  have such narrow widths.

## 2.4 Exotic hadrons

To deepen understanding of how confinement arises, ASU is working with the GlueX Collaboration in Hall D to search for exotic hybrids with masses up to 2.5 GeV. Exotic hadrons (“exotics”) are classified as one of three types: glueballs, tetraquarks, and hybrids. Glueballs

Table 1: “Well-known”  $\Xi$  resonances listed in the PDG summary [14].

State	$J^P$	Width (MeV)	PDG rating
$\Xi$	$\frac{1}{2}^+$		****
$\Xi(1530)$	$\frac{3}{2}^+$	9.1	****
$\Xi(1690)$	$?^?$	<10	***
$\Xi(1820)$	$\frac{3}{2}^-$	24	***
$\Xi(1950)$	$?^?$	60	***
$\Xi(2030)$	$\geq \frac{5}{2}^?$	20	***

Table 2: PDG values for branching ratios of excited  $\Xi$  states [14].

State	$\Lambda K$	$\Sigma K$	$\Xi\pi$
$\Xi(1530)$			100 %
$\Xi(1690)$	seen	seen	seen
$\Xi(1820)$	large	small	small
$\Xi(1950)$	seen	seen?	seen
$\Xi(2030)$	20%	80%	small

are states that completely lack valence quarks. The lightest glueballs should have  $J^{PC} = 0^{++}$  or  $2^{++}$ , and are expected to mix with constituent quark states with the same quantum numbers. Tetraquarks are comprised of two  $q\bar{q}$  states, and are the product of two  $SU(3)$  octets that can be represented as

$$\mathbf{8} \otimes \mathbf{8} = \mathbf{27} \oplus \mathbf{10} \oplus \overline{\mathbf{10}} \oplus \mathbf{8}_1 \oplus \mathbf{8}_2 \oplus \mathbf{1}.$$

Hybrid states in a constituent  $q\bar{q}g$  model are built from the usual  $q\bar{q}$  constituent-quark representation with the promotion of one or more gluons from virtual to real. For a hybrid state, a  $q\bar{q}$  colored state interacts with real constituent colored gluon(s) to form an overall colorless state. In contrast to glueballs and tetraquarks, hybrids are only expected to exist in nonets similar to those for the constituent quark model. Exotics, however, can have quantum numbers  $J^{PC}$  that differ from those of hadrons constructed with the simple constituent quark model. Finding particles with exotic quantum numbers  $J^{PC}$  serves as the “smoking gun” for determining if a state is exotic.

Some guidance in the search for hybrid states has come from lattice QCD predictions. For example, a lattice calculation performed by the Hadron Spectrum Collaboration (HSC) in 2013 [17] found hybrid states in supermultiplets with  $J^{PC} = 0^{+-}, 1^{-+}, 2^{+-},$  and  $1^{--}$ . This HSC model description suggests that those hybrids have the structure  $([q\bar{q}]_{\mathbf{8}_c} \otimes \mathbf{G}_{\mathbf{8}_c})$ . States of particular importance for the search of hybrids have the exotic quantum numbers of  $J^{PC} = 0^{+-}, 1^{-+}, 2^{+-}$ .

Table 3 shows several possible decays of exotic mesons of interest for the GlueX experiment. Currently, there are two exotic  $J^{PC} = 1^{-+}$  states ( $\pi_1(1400)$  and  $\pi_1(1600)$ ) listed by the Particle Data Group [14]. For the  $\pi_1(1400)$ , the decay modes that have been seen are  $\eta\pi^0$  and  $\eta\pi^-$ , while for  $\pi_1(1600)$  the decays seen are  $b_1\pi, \eta'\pi^-$  and  $f_1\pi$ . The interpretation of the  $\pi_1(1400)$  as a hybrid is problematic [18–20]. A hybrid meson ( $q\bar{q}g$ ) state can either have an angular excitation between the quark+anti-quark system and the gluon (said to be “gluon excited”) or the excitation can be exclusively between the quark and anti-quark (“quark excited”). For the gluonic angular-excitation, within the  $q\bar{q}g$  constituent model, a decay of a hybrid into two fundamental mesons is suppressed. This would make the  $\pi(1400) \rightarrow \eta\pi$  decay unlikely in the gluon-excited case. However, a quark excitation can proceed into two fundamental mesons, though the branch into the  $\eta$ -singlet is favored over the  $\eta$ -octet. Since no search for  $\pi(1400) \rightarrow \eta'\pi$  has been successful, there is some doubt that the  $\pi_1(1400)$  is a hybrid. Instead, some have suggested that the  $\pi_1(1400)$  is a tetraquark state [18–20].

In addition to the  $\pi_1$  exotic states, there should be corresponding isospin  $I = 0$  nonet members if the  $\pi_1$  is a hybrid. Establishing these isoscalar members for the nonets is important in order to verify these exotics as being hybrids. The tetraquark state with  $J^{PC} = 1^{-+}$  excludes the presence of an isosinglet, and is fully contained within the **20**-plet ( $\mathbf{10} \oplus \overline{\mathbf{10}}$ ). Thus, identifying an isosinglet state with  $J^{PC} = 1^{-+}$  excludes that state as being a tetraquark.

In ASU’s Hall B studies, the group extensively utilized the  $\eta$  and  $\eta'$  to filter out  $I = 3/2$  resonances from the nucleon resonance spectrum. For Hall D, we will similarly use the  $\eta'_1$  to filter out tetraquark states from the spectrum of exotic meson states. The  $K^*\bar{K}$  branch is a prime candidate for early detection of the  $\eta'_1$  hybrid. However, prior to our search for  $\eta'_1 \rightarrow K^*\bar{K}$ , we have decided to map out the lower mass states going  $K^*\bar{K}$ , eventually working our way towards the expected mass range of the  $\eta'_1$  hybrid of about 2 GeV.

Table 3: Possible decay modes of exotic hybrids that will be explored by GlueX.

Hybrid meson	$J^{PC}$	Reachable with limited running	Reachable with longer running	Challenging even with longer running
$b_0$	$0^{+-}$	—	—	$\pi(1300)\pi$ , $h_1\pi$ , $f_1\pi$ , $b_1\pi$
$h_0$	$0^{+-}$	—	$b_1\pi$	$h_1\eta$
$h'_0$	$0^{+-}$	—	$K_1(1270)K$	$K(1460)K$ , $h_1\eta$
$\pi_1$	$1^{-+}$	$\pi\rho$	$\pi b_1$ , $\pi f_1$ , $\pi\eta'$	$\eta a_1$
$\eta_1$	$1^{-+}$	$\eta f_2$ , $a_2\pi$	$\eta f_1$ , $\eta\eta'$	$\pi(1300)\pi$ , $a_1\pi$
$\eta'_1$	$1^{-+}$	$K^*K$	$K_1(1270)K$ , $K_1(1410)K$ , $K_2^*K$ , $\eta\eta'$	—
$b_2$	$2^{+-}$	$\omega\pi$ , $a_2\pi$ , $\rho\eta$	—	$f_1\rho$ , $a_1\pi$ , $h_1\pi$ , $b_1\eta$
$h_2$	$2^{+-}$	$\rho\pi$	$b_1\pi$ , $\omega\eta$	$f_1\omega$
$h'_2$	$2^{+-}$	—	$K_1(1270)K$ , $K_1(1410)K$ $K_2^*K$ , $\phi\eta$	$f_1\phi$

## 2.5 Past accomplishments and works in progress

The ASU Meson Physics Group has been working on electro- and photo-produced reactions from the proton. For the electro-production work we have primarily utilized undergraduates to isolate a variety of strangeness containing states. The graduate students work on GlueX photoproduction data to uncover  $\Xi^*$  baryons, and meson states that decay  $K^+K^-\pi^0$ .

Due to the transient and unpredictable nature of including undergraduates in advanced scientific study, the direction of the undergraduate work is completely determined by opportunity and is not planned far in advance. As stated in the introduction, our undergraduates have investigated  $ep \rightarrow epK^*K$  (Patrick Walker [2,3]),  $ep \rightarrow eK\Lambda(1520)$  (Rebecca Osar [4,5]),  $ep \rightarrow ep\phi\pi$  (Emily Lamanga [6]) and  $\gamma p \rightarrow p\phi$  (Anna Costelle [7]). In addition to the work listed above, the undergraduates have participated in the investigation of machine learning algorithms (Mohamed Mohamed [9], Kevin Scheuer [10]). Some of the undergraduates have won local ASU awards for their work: Patrick Walker (ASU Department of Physics Research Award), Anna Costelle (ASU Women in Physics Award) and Mohamed Mohamed (CISA Undergraduate Research Award).

In order to keep the discussion of our undergraduate work to be of reasonable length, I only highlight the work performed by Ms. Osar towards obtaining cross section measurements for  $ep \rightarrow eN^*$  where  $N^* \rightarrow K\Lambda(1520)$ . Ms. Osar's analysis has progressed more than the other undergraduates in the group. She has background subtracted  $\Lambda(1520)$  signals from invariant mass  $K^-p$  events for each bin in invariant mass  $K^+\Lambda(1520)$  shown in Figure 5. The fit shown on the figure (solid black line) has a Gaussian center at 2.299 GeV that coincides with the two-star  $N(2300)$  resonance. Additionally, there is an interesting feature near 3.4

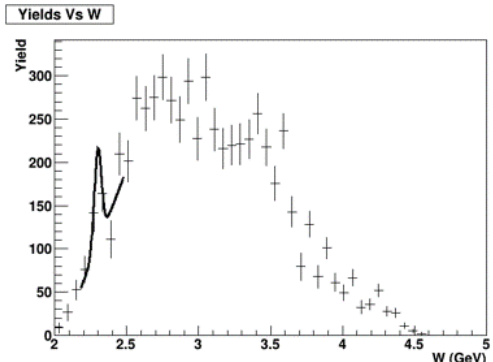

Figure 5: Invariant mass of  $K^+\Lambda(1520)$ .

GeV that should be explored. Ms. Osar has recently completed work on a event generator for the reaction and we are in the process of determining the detector efficiency for the mass bins given in Figure 5.

The GlueX photoproduction data on mesons that decay  $K^*\bar{K}$  and the isolation of excited  $\Xi$  baryon states forms the most important component of our research and is discussed next.

### 2.5.1 Work on $K^*\bar{K}$ states

Former ASU graduate student Sebastian Cole studied mesons that decay by way of  $K^*\bar{K}$ . The invariant mass of  $K^-\pi^0$  from  $\gamma p \rightarrow pK^+K^-\gamma\gamma$  events is shown in Figure 6 with vertical red lines indicating the selection of events with  $K^{*-}(892)$  meson. Taking those events that are consistent with the  $K^{*-}(892)$  meson, an invariant mass of  $K^{*-}(892)K^+$  is formed (see Figure 7). Very similar results are obtained for the  $K^{*+}(892)K^-$  case where  $K^{*+}(892)$  is formed from  $K^+\pi^0$ .

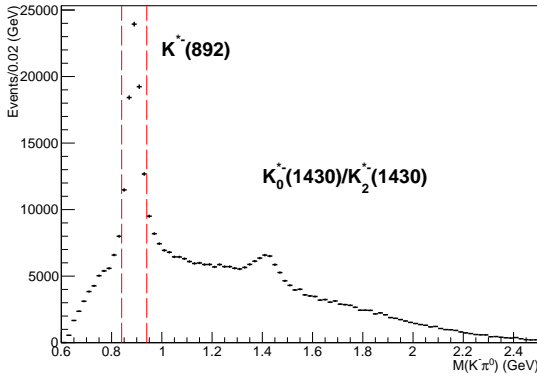

Figure 6: Invariant mass of  $K^-\pi^0$ .

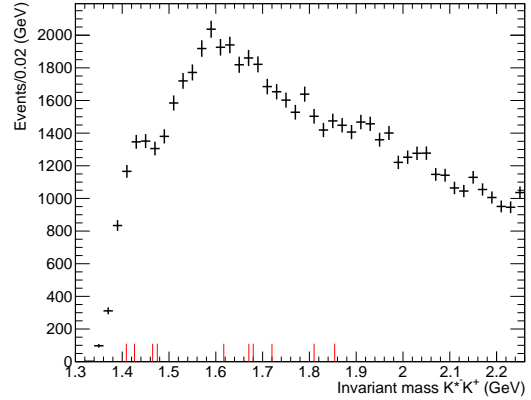

Figure 7: Invariant mass of  $K^{*-}(892)K^+$ .

The intensity utilizing a polarized photon beam can be written as [21]

$$I(\Omega, \Omega_H, \Phi) = I^0(\Omega, \Omega_H) - P_\gamma I^1(\Omega, \Omega_H) \cos(2\Phi) - P_\gamma I^2 \sin(2\Phi), \quad (1)$$

where  $P_\gamma$  is the degree of the linear polarization of the incident photon beam. Each  $I$  in Equation 1 can be defined in terms of decay amplitudes:

$$I^0(\Omega, \Omega_H) = \frac{\kappa}{2} \sum_{\lambda} A_{\lambda}(\Omega, \Omega_H) A_{\lambda}^*(\Omega, \Omega_H) \quad (2)$$

$$I^1(\Omega, \Omega_H) = \frac{\kappa}{2} \sum_{\lambda} A_{-\lambda}(\Omega, \Omega_H) A_{\lambda}^*(\Omega, \Omega_H) \quad (3)$$

$$I^2(\Omega, \Omega_H) = i \frac{\kappa}{2} \sum_{\lambda} \lambda A_{-\lambda}(\Omega, \Omega_H) A_{\lambda}^*(\Omega, \Omega_H). \quad (4)$$

The amplitudes are then expanded in terms of partial waves

$$A_{\lambda} = \sum_i \sum_m T_{\lambda,m}^i B, \quad (5)$$

where  $T$  are the partial wave amplitudes and  $B$  the matrix element associated with the two rotations of interest:

$$B \equiv \langle j_1 m_1 j_2 m_2 | R^{(1)} R^{(2)} | J m \rangle, \quad (6)$$

where the  $j_1$  represents the quantum number for the orbital angular momentum from the decay of the resonance meson to the  $K^*$  vector meson and the pseudoscalar  $\bar{K}$  meson, with the  $j_2$  quantum number being associated with the spin of the  $K^*$  vector meson. The rotations  $R^{(1)}$  and  $R^{(2)}$  act on  $|j_1 m_1\rangle$  and  $|j_2 m_2\rangle$ , respectively.

The matrix element can be put into the form

$$B = \sum_{m''} \sum_{m'} \langle J m' | j_1 m_1 j_2 m_2'' \rangle D_{m m'}^{J*}(R_r^p) D_{m_2'' m_2}^{j_2*}(R_v^p), \quad (7)$$

where  $\langle J m' | j_1 m_1 j_2 m_2'' \rangle$  is the Clebsch-Gordan coefficient that connects the initial and final configurations of angular momentum and the terms of the form  $D_{mn}^j$  are Wigner D-Functions, with  $R_r^p$  being the passive rotation pointing towards the  $K^*$  as measured in the helicity frame of the resonant meson and  $R_v^p$  being the passive rotation pointing towards the  $\pi$  as measured in the helicity frame of the  $K^*$  vector-meson.

Invariant mass distributions for  $K^*\bar{K}$  with  $J = 0, 1, 2$  values determined by PWA can be seen in Figures 8, 9 and 10, respectively. For each Figure 8 through 10, the red line represents a total fit to the data. For  $J = 0$  (Figure 8) the green line represents the  $\eta(1405)$ , while blue is the  $\eta(1475)$  and the yellow line is a third-degree polynomial background. For  $J = 1$  (Figure 9) the magenta line represents the  $f_1(1420)$ , the green line represents  $f_1(1510)$  and an exponential background is cyan. For  $J = 2$  (Figure 10) the green line represents the  $f_2(1430)$ , the blue line represents  $f_2'(1525)$  while the background contribution is assumed as the tail of the  $f_2(1260)$  shown in magenta.

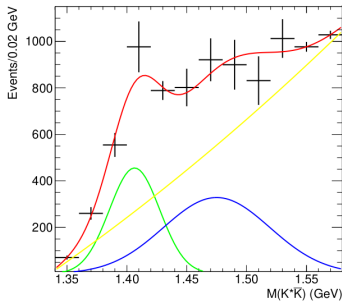

Figure 8:  $M(K^*\bar{K})$ ,  
 $J = 0$  from PWA.

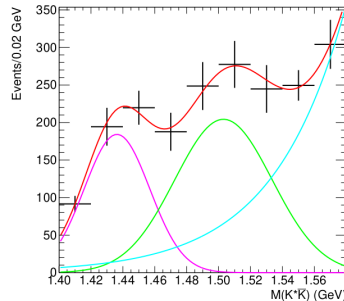

Figure 9:  $M(K^*\bar{K})$ ,  
 $J = 1$  from PWA.

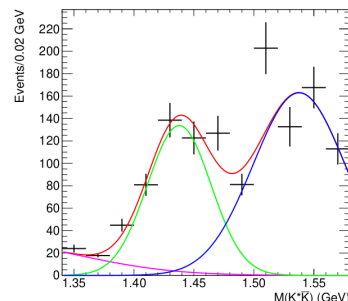

Figure 10:  $M(K^*\bar{K})$ ,  
 $J = 2$  from PWA.

The fit parameters, along with PDG values, for each of the extracted mesons shown in Figures 8-10 can be found in table 4.

Of particular interest are the  $\eta(1405)$  and  $f_2(1430)$  states. The  $\eta(1405)$  has not been seen in  $\gamma\gamma$  collisions, pointing to a possible large gluonic content, while the  $f_2(1430)$  is a state that is omitted from the PDG Summary Tables due to a paucity of data. Each of these potentially interesting states ( $\eta(1405)$  and  $f_2(1430)$ ) appear to show up rather strongly in our studies. Our evidence of  $f_2(1430)$  will hopefully help more firmly establish that particle.

$J$	PID	PDG center (MeV)	PDG width (MeV)	Fit center (MeV)	Fit width (MeV)
0	$\eta(1405)$	$1408.8 \pm 2.0$	$50.1 \pm 2.6$	$1406 \pm 2$	$49.46 \pm 7.07$
0	$\eta(1475)$	$1475 \pm 4$	$90 \pm 9$	$1475 \pm 10$	$105.8 \pm 2.24$
1	$f_1(1420)$	$1426.3 \pm 0.9$	$54.5 \pm 2.6$	$1436 \pm 11$	$48.40 \pm 4.17$
1	$f_1(1510)$	$1518 \pm 5$	$73 \pm 25$	$1503 \pm 5$	$71.78 \pm 12.76$
2	$f_2(1430)$	$\sim 1430$	NA	$1438 \pm 4$	$62.36 \pm 5.70$
2	$f_2(1525)$	$1517.4 \pm 2.5$	$86 \pm 5$	$1538 \pm 4$	$90.03 \pm 13.73$

Table 4: Comparison of the Fit Parameters for Figures 8-10 With Respect to the PDG.

## 2.5.2 Work on $\Xi^*$ states

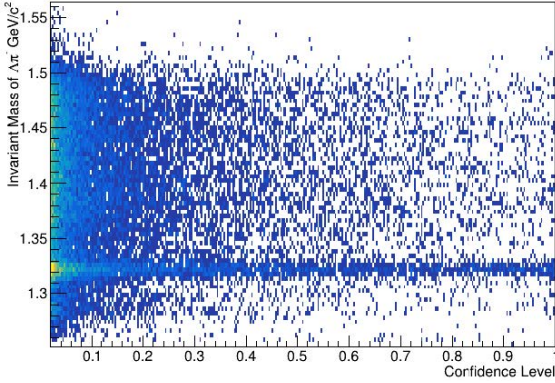

Figure 11: Mass of  $\Lambda\pi^-$  versus confidence level.

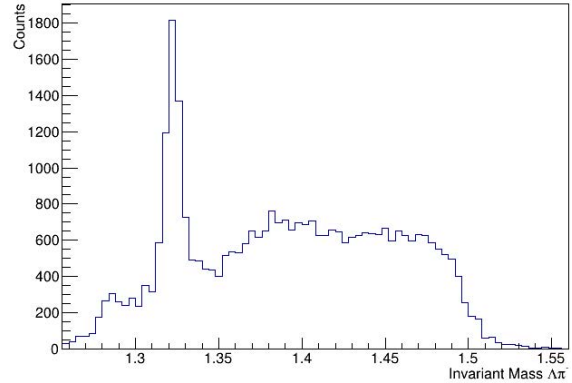

Figure 12: Invariant mass of  $\Lambda\pi^-$  when confidence level is  $> 10^{-4}$ .

Graduate student Brandon Sumner is heading up the  $\Xi^*$  analysis effort for the group. The analysis starts with a kinematic fit. The initial reaction of interest is  $\gamma p \rightarrow K^+ K^+ \pi^0 \Xi^-$ , where  $\Xi^- \rightarrow \Lambda \pi^-$ . The  $\Lambda$  and  $\pi^0$  are constrained to the PDG masses within the kinematic fit, whereas the  $\Xi^-$  mass is not. A plot of the confidence level from kinematic fitting versus the invariant mass of  $\Lambda\pi^-$  is shown in Figure 11. Mr. Sumner performed a study to determine the confidence level that minimizes the fractional uncertainty of extracted  $\Xi(1520)$  states, and found it best to accept all events with a confidence level greater than  $10^{-4}$ . Upon a confidence level of  $10^{-4}$ , an invariant mass of  $\Lambda\pi^-$  given in Figure 12 is determined, where the peak at 1.320 GeV is the ground state  $\Xi$ . The  $\Xi$  is then defined as those events with invariant mass  $\Lambda\pi^-$  between 1.31 and 1.34 GeV.

In addition to exploring the branch  $\Xi^{*-} \rightarrow \Xi^- \pi^0$ , we investigate the branch  $\Xi^{*-} \rightarrow K^- \Lambda$ . For the case of  $\Xi^{*-} \rightarrow K^- \Lambda$ , the  $\Lambda$  is not constrained and a confidence level study is performed on the  $\Xi(1820)$  in a similar manner as described for the  $\Xi^{*-} \rightarrow \Xi^- \pi^0$  branch using  $\Xi(1530)$ .

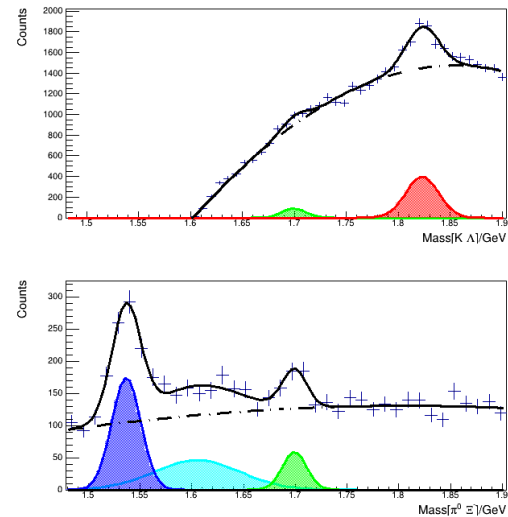

Figure 13: Simultaneous fit of Mass[ $\Xi^{*-}$ ] branches:  $\Xi^{*-} \rightarrow K^- \Lambda$  (top panel) and  $\Xi^{*-} \rightarrow \Xi^- \pi^0$  (bottom panel).

A simultaneous fit was performed on  $\Xi^{*-}$  states utilizing 2018 data for both branches described above. Figure 13 shows the invariant mass of  $K^-\Lambda$  from the reaction  $\gamma p \rightarrow K^+K^+K^-\Lambda$  in the top panel, while the bottom panel shows the invariant mass of  $\Xi^-\pi^0$  from the reaction  $\gamma p \rightarrow K^+K^+\Xi^-\pi^0$ . The fit consists of four  $\Xi^{*-}$  states ( $\Xi(1530)$ ,  $\Xi(1620)$ ,  $\Xi(1690)$ ,  $\Xi(1820)$ ) along with polynomial backgrounds. The simultaneous fit constrained the center and widths of the  $\Xi^{*-}$  states to be identical for both top and bottom panels of Figure 13, but allowed the amplitudes to vary independently. For both branches within the simultaneous fit, the background was described by a third degree polynomial with parameters being independent between the branches. Within Figure 13, solid lines represent the full fit, dashed-dotted lines are the polynomial backgrounds with solid colors representing the  $\Xi^{*-}$  states, where blue is  $\Xi(1530)$ , turquoise represents  $\Xi(1620)$ , green is the  $\Xi(1690)$  and red is the  $\Xi(1820)$ .

The  $\Xi(1530)$  is a four-star state,  $\Xi(1690)$  and  $\Xi(1820)$  are three-star, and the  $\Xi(1620)$  is a one-star that is omitted from the summary table. Although the  $\Xi(1690)$  has a three-star designation, the PDG still lists the  $J^P$  as unknown with  $J^P = ??$  with an unknown branching ratio  $\Gamma(K^-\Lambda)/\Gamma(\Xi^-\pi^0)$  that we plan to measure.

Detector simulation studies have been performed for the  $\Xi(1530)$  state to allow for detector efficiencies to be calculated, but there remains work to be done towards improving the event generator. The generator employed in determining the detection efficiencies is a phase space generator that considers the initial part of the reaction  $\gamma p \rightarrow K^+K^+\Xi^-$  as a one-step process. However, due to OZI suppression, a two step process is far more likely. Brandon Sumner has nearly completed work on a generator that better matches the reaction of interest:  $\gamma p \rightarrow K^+Y$ , where  $Y$  is a very wide high-mass hyperon that decays  $Y \rightarrow K^+\Xi^{*-}$ .

Preliminary  $\gamma p \rightarrow K^+K^+\Xi(1530)$  cross sections in term of incident photon energy are shown in Figure 14.

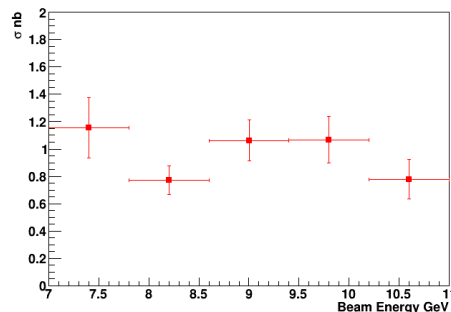

Figure 14: Preliminary cross section of  $\Xi^-(1530)$ .

## 2.6 Publications during the current grant

Several papers have been published during the current grant period [22–34]. Of those papers, we had direct involvement in writing the text related to the triplet polarimeter for the GlueX beamline and detector paper [28] and for providing the polarization values used in the determination of beam asymmetries for the photoproduction from the proton for  $\eta$ ,  $\eta'$  [32];  $K^+\Sigma^0$  [30] and  $\pi^-\Delta^{++}$  [26]. We provided the initial event generator used for background studies for the early analysis of  $J\psi$  that eventually led to publication [33]. The  $\pi^-\Delta^{++}$  [26] paper utilized a method developed by the PI for the determination of beam asymmetries [35] and the PI had discussions with the person that led the GlueX analysis effort (J. Zarling) regarding the implementation of that method. The PI was heavily involved with the FROST group prior to this current grant and two of the papers [22, 34] were from those efforts. The remaining papers had involvement from group members that was less substantial than described above.

### 3 Research plan

The timeline given here represents a “good faith” estimate that assumes that funds for the proposed work are awarded at the level requested and no unforeseen issues arise.

A bulleted list of milestones can be found in section 8.

Throughout the grant period, additional data will be taken with both Halls B and D and we will contribute towards the normal collaborative service work expected from us. For the GlueX collaboration in Hall D, we will continue our responsibility for maintaining the ASU-built triplet polarimeter. We will also continue analyzing TPOL data required for providing the GlueX collaboration the measured values of polarization for the photon beam that is incident on the GlueX target. As analyses progress, preliminary data will be presented at workshops and meetings. We will be deeply engaged in multiple analyses from both Hall B and GlueX running, will have mature software tools for analyzing data from those facilities, and be able to fold additional students into the ASU efforts.

*During Year 1*, graduate student Alan Gardner will begin working at Jefferson Lab. Alan will push forward with his partial wave analysis of resonant mesons with  $K^+ K^- \pi^0$  decay products. A second graduate student funded by the new award will enter the group to extend the cascade analysis of Brandon Sumner

*During Year 2*, Alan Gardner will return to ASU and will push the  $K^*K$  analysis as far past 2 GeV as is reasonably possible. Mr Gardner will provide his prospectus and successfully complete all other requirements to obtain the status of PhD candidate at Arizona State University. The second graduate student will begin working at Jefferson Lab and will, along with the PI and undergraduates, begin to pursue the analysis of Cascade states from Hall-B data.

*During Year 3*, The second graduate student will return from Jefferson Lab. and continue searching for cascade states within the data from Halls B and D. Alan Gardner will finish our work on the exploration of meson resonances with  $K^+ K^- \pi^0$  decay products, provide the GlueX collaboration with an analysis note regarding his studies and, ideally, lead in the publication of the results. By the end of the third year of the award period, Alan Gardner will have successfully defended his dissertation and will have received his Ph.D.

### 4 Impact of other work on this grant’s resources

PI Dugger is a tenure-track faculty member at ASU with an academic year contract. ASU requires all tenured and tenure-track faculty members to contribute effort during the academic year in the areas of teaching, research, and service. The vast majority of the research effort from the PI during the academic year is committed to the research to be undertaken in this proposal, with two months of summer effort entirely committed to this proposal. The PI has no effort committed to any other proposal.

### 5 Human resource development

Based at one of the nation’s largest and most diverse major public research universities, instruction and mentoring form a central feature of this project. In addition to the training and mentoring, the students develop professionally by presenting their results at a variety of meetings.



As expected, the scientific results of the investigations outlined in Section 2 will be broadly disseminated through national and international conference presentations, workshops, reports, and refereed publications, and will be archived in public databases.

As indicated in Sections 1 and 2.5, there have been numerous occasions where undergraduate students have presented their work at ASU. Not mentioned, thus far, were the times that undergraduate students Emily Lamagna, Rebecca Osar, or Patrick Walker presented results to the CLAS12 Very Strange Group. Currently we are planning for two of our undergraduates (Emily Lamagna and Rebecca Osar) to present results at the Four Corners Section (4CS) of American Physical Society (APS) this October and at the Conference for Undergraduate Women in Physics meeting at the University of Arizona in January 2022.

The graduate students have presented results in GlueX working groups, collaboration meetings, and to a wider physics audience at meetings of the APS. Sebastian Cole presented  $K^*K$  events at the Fall Meeting of the APS Division of Nuclear Physics (DNP) in 2019 [36], while Brandon Sumner presented his results at the APS April Meeting in 2021 [37], and will be presenting his most recent results at the DNP meeting this October.

## 6 Requested resources and justification

The justifications for the items listed in the proposal budget are provided here.

### 6.1 Senior personnel

**Summer salary support** (2 months) is being sought for the Principal Investigator each year of the project to enable his effort to continue during the summer months when his full time can be devoted to the research described above. The PI has extensive experience working in both Halls B and D at Jefferson Lab. While active in all areas of the project mentoring the graduate student and undergraduate students working on the hadronic production efforts in Halls B and D.

### 6.2 Other Personnel

#### 6.2.1 Graduate Research Associates

Support is sought for two graduate students. The funding requested encompasses for each supported student 4.5 academic months per academic year and 1.5 summer months per calendar year. At ASU, this translates to 20 hours/week during the academic year and summer. The budget is estimated based on an expected institutional base salary of \$55,000, commensurate with salaries for currently employed GRAs at ASU. Student participation will greatly enhance the productivity of the group beyond the efforts of the PI, and also deliver the human resource benefits noted above, enhancing the nation's supply of well-trained scientists. Graduate student salaries listed in the budget are based on the standard rate for graduate research associates in the Department of Physics with an additional three months of summer support.

### 6.3 Fringe benefits.

Arizona State University defines fringe benefits as direct costs, estimates benefits as a standard percent of salary applied uniformly to all types of sponsored activities, and charges benefits to sponsors in accordance with the federally-negotiated rates in effect at the time salaries are incurred. Benefit costs are expected to increase approximately 3% per year; the

rates used in the proposal budget are based on the current Federally-Negotiated Rate Agreement plus annual escalation for out-years. The proposal's Fringe Benefits were negotiated and approved by the U.S. Department of Health and Human Services. For purposes of this proposal the following rates are being used:

- Faculty members: 27.3%, 28.12%, and 28.96% of salary for Year 1, 2, and 3, respectively.
- Graduate research assistants/associates: 10.51%, 10.83%, and 11.15% of salaries for Year 1, 2, and 3, respectively.

## **6.4 Total salaries, wages and fringe benefits**

An estimated cost escalation has been included in the out years, consistent with ASU policy. The total request for salaries, wages and fringe benefits: Year 1 -\$84,627, Year 2 -\$87,507, Year 3 -\$90,484.

## **6.5 Equipment**

No funds are requested for equipment.

## **6.6 Travel**

The travel budget was estimated in accordance with the University's travel policy based on current air fares, current federal and ASU authorized per diem rates, airport shuttle services, and, if applicable, conference registration fees and/or car rental. At the time of this proposal, ASU's travel system software provider, Concur Technologies, assesses a minimal charge per person for each travel expense report submitted. This expense is a direct cost charged per trip.

For each year of support, we have allocated five trips to Jefferson Lab, with three of those trips having a duration of ten days and nine nights, and the remaining two JLab trips having durations of six days and five nights. These trips will enable at least one additional person from ASU beyond the on-site graduate student to participate in collaboration activities, meet service obligations, discuss analyses and results with collaborators, and make presentations at collaboration meetings. Expenses include: roundtrip airfare to Virginia for \$400, lodging at \$115/night, per diem at \$51/day, \$100 for ground transportation and an \$11 ASU Concur travel fee.

Travel required of graduate students for long-term stay at Jefferson Lab is comprised of two separate one-way trips. Each leg of the long-term trip is assumed to be by automobile requiring four nights lodging and five days per diem. The first leg of Alan Gardner's long-term trip is scheduled for the first year, with return leg during the second year. The second graduate student is scheduled to leave during the second year and return on the third year. Expenses for each way include: 4 nights lodging at \$147/night, 5 days per diem at \$56/day, \$100 for incidentals, \$1,028 for milage and and an \$11 ASU Concur travel fee.

In addition to the JLab trips, four trips are allocated per year for giving talks at conferences. Washington, DC has been used for trip estimation purposes. Expenses include: \$400 for roundtrip airfare, 4 nights lodging at \$251/night, 5 days per diem at \$66/day, \$150 for registration fees and an \$11 ASU Concur travel fee.

The travel funds being requested: Year 1 -\$18,539, Year 2 -\$21,101, Year 3 -\$19,605.

## 6.7 Other direct costs

Funds for materials and supplies are requested at the level of approximately \$4,000 per year for computing equipment replacement and repair, (including upkeep of the computer clusters owned by the group), plus additional funds for miscellaneous supplies and consumables. The breakdown per year is as follows: Year 1 -\$4,186, Year 2 -\$4,159, Year 3 -\$3,920.

**Tuition remission** for graduate students is a required charge at ASU for graduate students supported by external funding. The remission is charged to projects in proportion to the amount of effort the graduate student will work on the project, and those tuition charges are exempt from Facilities and Administrative Costs. The tuition charge per graduate student is based upon the currently approved university tuition and fee schedules and is calculated as follows for each student: Year 1 - \$19,868; Year 2 - \$21,457; Year 3 - \$23,174.

No participant costs or equipment purchases are budgeted.

## 6.8 Total direct costs

The total direct costs for each budget year of this award will be \$147,088, \$155,681, and \$160,357 for Years 1, 2, and 3, respectively.

## 6.9 Indirect costs

Indirect costs are calculated on Modified Total Direct Costs (MTDC) using Facilities and Administrative Costs rates approved on July 29, 2021. Items excluded from the indirect cost calculation include are capital equipment, subcontracts over the first \$25,000, tuition remission, participant support costs, rental/maintenance of off-campus space, and patient care fees. The off-campus research rate of 26% is applied for all years of the project.

## 6.10 Total Direct and Indirect costs

The total direct and indirect costs being requested for each 12-month period of this award amount to \$175,000, \$185,000, and \$190,000 for Years 1, 2, and 3, respectively. The total over the requested three-year periods \$550,000.

# 7 Institutional support

Arizona State University provides support to to ASU Meson Physics Group at the Polytechnic campus located in Mesa, AZ. ASU provides utilities, basic telecommunication service, 1 Gbs internet access, approximately 500 square feet of dedicated lab space, and sufficient office space for the principal investigator. These institutional resources are sufficient to support the research efforts related to this proposal for all group members with the proposal funded at the level requested.

# 8 Summary of meaningful metrics

*Metrics that are common to each year:*

- TPOL (GlueX)
  - Provide polarization values for data taken during previous year
- Search for strangeness (CLAS12)
  - The PI will continue to assist in analysis issues that arise regarding strangeness production using CLAS12.

- Undergraduate students will obtain experience in analyzing nuclear physics data by reconstructing various strangeness states.

*Metrics specific to year 1:*

- Meson resonance analysis (GlueX)
  - Alan Gardner will improve the PWA results by constraining the fits over the mass spectrum through Breit-Wigner signals along with background functions (currently mass fitting is performed after the PWA extraction of definite  $J$  states).
  - Alan Gardner will extend the fit range to include masses up to 2 GeV.
- Cascade analysis (GlueX)
  - Graduate Student number 2 (GS2) will have begun working with the ASU Meson Physics Group by becoming familiar with, and continuing the work of (then graduated PhD student) Brandon Sumner.

*Metrics specific to year 2:*

- Meson resonance analysis (GlueX)
  - Alan Gardner will have pushed his PWA to include mass states as far above 2 GeV as is reasonably possible.
  - Alan Gardner will provide his prospectus and successfully complete all other requirements to obtain the status of PhD candidate at Arizona State University.
- Cascade analysis (GlueX and CLAS12)
  - GS2 will extend the  $\Xi^*$  PWA to include constraints over multiple decay branches
  - GS2 and the PI will start exploring the excited cascade states present in CLAS12 data with an eye towards creating a combining analysis of CLAS12 (electroproduction) and GlueX (photoproduction) data for signal that may be too weak to extract when using only one of the production types.

*Metrics specific to year 3:*

- Meson resonance analysis (GlueX)
  - We will finish our work on the exploration of meson resonances with  $K^+ K^- \pi^0$  decay products
  - Alan Gardner will provide the GlueX collaboration with an analysis note regarding his studies and, ideally, lead in the publication of the results.
  - Alan Gardner will have successfully defended his dissertation and will have received his Ph.D.
- Cascade analysis (GlueX and CLAS12)
  - GS2 will measure as many branching ratios and other physical parameters related to  $\Xi^*$  states as is reasonably possible.
  - GS2 will extend the  $\Xi^*$  PWA to include constraints needed to couple photoproduction data to electroproduction data for any signals that are too small to be extracted within a single production type.

# Appendices

## A Bibliography and references cited

### References

- [1] A. Aprahamian *et al.*, *Reaching for the Horizon: The 2015 Long Range Plan for Nuclear Science*, Nuclear Science Advisory Committee (2015),  
URL: `{http://science.energy.gov/~media/np/nsac/pdf/2015LRP/2015\_LRPNS\_091815.pdf}`
- [2] Walker, P. and Dugger, M., *Isolation of the phi-meson from  $ep \rightarrow epK^+K^-$  events* (presentation at the College of Integrative Sciences and Arts Virtual Student Research Day, Dec. 2020, Polytechnic Campus, Arizona State),  
URL: `http://meson.hldsite.com/presentations/CISAFall20/PatrickWalker\_CISA\_Fall\_2020.pdf`
- [3] Walker, P., *Search for new states that decay  $K^*K$*  (presentation at the 17th Annual Undergraduate Physics Symposium, May 2021, Tempe Campus, Arizona State University),  
URL: `https://youtu.be/Buu2YDIrUK4`
- [4] Osar R. and Dugger M., *Event generator for  $\gamma p \rightarrow pKK$  events* (presentation at the College of Integrative Sciences and Arts Virtual Student Research Day, Dec. 2020, Polytechnic Campus, Arizona State),  
URL: `http://meson.hldsite.com/presentations/CISAFall20/RebeccaOsar\_CISA\_Fall\_2020.pdf`
- [5] Osar, R., *Search for high-mass resonances decaying to  $K\Lambda^*$*  (presentation at the 17th Annual Undergraduate Physics Symposium, May 2021, Tempe Campus, Arizona State University),  
URL: `https://youtu.be/Q2YhBCv1riE`
- [6] Lamagna, E., *On the road to constructing events that decay  $\phi\pi^0$  using electroproduction with a proton target* (presentation at the 17th Annual Undergraduate Physics Symposium, May 2021, Tempe Campus, Arizona State University),  
URL: `https://youtu.be/3AZP9fjStuc`
- [7] Costelle, A., *Construction of Event Generators for Strangeness-Containing Final States* (presentation at the 17th Annual Undergraduate Physics Symposium, May 2021, Tempe Campus, Arizona State University),  
URL: `https://youtu.be/tKCB4t\_G2yk`
- [8] Mohamed, M. and Dugger, M., *Simulations for energy depositions in a phantom cell of water for different types of therapy beams* (presentation at the College of Integrative Sciences and Arts Student Research Day, Dec. 2019, Polytechnic Campus, Arizona

- State),  
 URL: <http://www.public.asu.edu/~dugger/student2019/PosterMoMoV2.pdf>
- [9] Mohamed, M. and Dugger, M., *Particle identification study using decision trees* (presentation at the College of Integrative Sciences and Arts Student Research Day, May 2020, Polytechnic Campus, Arizona State),  
 URL: <http://meson.hldsite.com/presentations/Poster2020/PosterMoMoSp20Final.pdf>
- [10] Scheuer, K. and Cole, S. and Dugger, M., *Evaluation of machine learning methods on simulated tracks to improve  $K$   $\pi$  identification in GlueX* (presentation at the College of Integrative Sciences and Arts Student Research Day, May 2020, Polytechnic Campus, Arizona State),  
 URL: <http://meson.hldsite.com/presentations/Poster2020/PresentationKevin2020.pdf>
- [11] G. Collaboration, *Mapping the Spectrum of Light Quark Mesons and Gluonic Excitations with Linearly Polarized Photons*, Jefferson Lab Experiment Proposal PR-06-102, GlueX Collaboration, Jefferson Lab (2006),  
 URL: <https://halldweb.jlab.org/DocDB/0012/001226/001/pac30.pdf>
- [12] C. Meyers, *Potential GlueX Physics During the First Two Years of 12 GeV Running*, Report, GlueX Collaboration, Jefferson Lab (2006),  
 URL: [https://halldweb.jlab.org/DocDB/0006/000621/002/gluex\\_pac.pdf](https://halldweb.jlab.org/DocDB/0006/000621/002/gluex_pac.pdf)
- [13] I. Adam *et al.*, *The DIRC particle identification system for the BaBar experiment*, Nucl. Instrum. Meth. **A538** (2005), pp. 281–357
- [14] P. Zyla *et al.*, *Review of Particle Physics*, PTEP **2020** (2020) (8), p. 083C01
- [15] S. Capstick and N. Isgur, *Baryons in a relativized quark model with chromodynamics*, Phys. Rev. **D34** (1986), p. 2809, [AIP Conf. Proc.132,267(1985)]
- [16] V. Crede and S. Capstick, *Bound States of  $N$ 's and  $\Xi$ 's*, in *Workshop on Excited Hyperons in QCD Thermodynamics at Freeze-Out (YSTAR2016) Mini-Proceedings* (2017), pp. 40–45,  
 URL: [http://inspirehep.net/record/1511541/files/1510585\\_40-45.pdf](http://inspirehep.net/record/1511541/files/1510585_40-45.pdf)
- [17] J. J. Dudek, R. G. Edwards, P. Guo and C. E. Thomas, *Toward the excited isoscalar meson spectrum from lattice QCD*, Phys. Rev. **D88** (2013) (9), p. 094505
- [18] S. U. Chung, E. Klempt and J. G. Korner,  *$SU(3)$  classification of  $p$ -wave  $\eta\pi$  and  $\eta'\pi$  systems*, Eur. Phys. J. **A15** (2002), pp. 539–542
- [19] F. Iddir and A. S. Safir, *The Decay of the observed  $J^{PC} = 1^{-+}(1400)$  and  $J^{PC} = 1^{-+}(1600)$  hybrid candidates*, Phys. Lett. **B507** (2001), pp. 183–192

- [20] F. E. Close and H. J. Lipkin, *New Experimental Evidence for Four Quark Exotics: The Serpukhov  $\phi\pi$  Resonance and the Gams  $\eta\pi$  Enhancement*, Phys. Lett. **B196** (1987), p. 245
- [21] V. Mathieu, M. Albaladejo, C. Fernández-Ramírez, A. Jackura, M. Mikhasenko, A. Pilloni and A. Szczepaniak, *Moments of angular distribution and beam asymmetries in eta pi0 photoproduction at GlueX*, Physical Review D **100** (2019) (5),  
URL: <http://dx.doi.org/10.1103/PhysRevD.100.054017>
- [22] N. Zachariou *et al.*, *Double polarisation observable G for single pion photoproduction from the proton*, Phys. Lett. B **817** (2021), p. 136304
- [23] U. Shrestha *et al.*, *Differential cross sections for  $\Lambda(1520)$  using photoproduction at CLAS*, Phys. Rev. C **103** (2021) (2), p. 025206
- [24] T. B. Hayward *et al.*, *Observation of Beam Spin Asymmetries in the Process  $ep \rightarrow e'\pi^+\pi^-X$  with CLAS12*, Phys. Rev. Lett. **126** (2021), p. 152501
- [25] M. Carver *et al.*, *Photoproduction of the  $f_2(1270)$  meson using the CLAS detector*, Phys. Rev. Lett. **126** (2021) (8), p. 082002
- [26] S. Adhikari *et al.*, *Measurement of beam asymmetry for  $\pi^-\Delta^{++}$  photoproduction on the proton at  $E_\gamma = 8.5$  GeV*, Phys. Rev. C **103** (2021), p. L022201,  
URL: <https://link.aps.org/doi/10.1103/PhysRevC.103.L022201>
- [27] T. Hu *et al.*, *Photoproduction of  $\eta$  mesons off the proton for  $1.2 < E_\gamma < 4.7$  GeV using CLAS at Jefferson Laboratory*, Phys. Rev. C **102** (2020) (6), p. 065203
- [28] S. Adhikari *et al.*, *The GlueX beamline and detector*, Nuclear Instruments and Methods in Physics Research Section A: Accelerators, Spectrometers, Detectors and Associated Equipment **987** (2021), p. 164807,  
URL: <https://www.sciencedirect.com/science/article/pii/S0168900220312043>
- [29] A. Celentano *et al.*, *First measurement of direct photoproduction of the  $a_2(1320)^0$  meson on the proton*, Phys. Rev. C **102** (2020) (3), p. 032201
- [30] S. Adhikari *et al.*, *Measurement of the photon beam asymmetry in  $\vec{\gamma}p \rightarrow K^+\Sigma^0$  at  $E_\gamma = 8.5$  GeV*, Phys. Rev. C **101** (2020), p. 065206,  
URL: <https://link.aps.org/doi/10.1103/PhysRevC.101.065206>
- [31] A. Schmidt *et al.*, *Probing the core of the strong nuclear interaction*, Nature **578** (2020) (7796), pp. 540–544
- [32] S. Adhikari *et al.*, *Beam asymmetry  $\Sigma$  for the photoproduction of  $\eta$  and  $\eta'$  mesons at  $E_\gamma = 8.8$  GeV*, Phys. Rev. C **100** (2019), p. 052201,  
URL: <https://link.aps.org/doi/10.1103/PhysRevC.100.052201>

- [33] A. Ali *et al.*, *First Measurement of Near-Threshold  $J/\psi$  Exclusive Photoproduction off the Proton*, Phys. Rev. Lett. **123** (2019), p. 072001,  
URL: <https://link.aps.org/doi/10.1103/PhysRevLett.123.072001>
- [34] P. Roy *et al.*, *First Measurements of the Double-Polarization Observables  $F$ ,  $P$ , and  $H$  in  $\omega$  Photoproduction off Transversely Polarized Protons in the  $N^*$  Resonance Region*, Phys. Rev. Lett. **122** (2019) (16), p. 162301
- [35] M. Dugger *et al.*, *Beam asymmetry  $\Sigma$  for  $\pi^+$  and  $\pi^0$  photoproduction on the proton for photon energies from 1.102 to 1.862 GeV*, Phys. Rev. C **88** (2013), p. 065203,  
URL: <https://link.aps.org/doi/10.1103/PhysRevC.88.065203>
- [36] Cole, S.,  *$K^*K$  in GlueX* (presentation at Fall Meeting of the American Physical Society Division of Nuclear Physics, 2019),  
URL: <http://www.public.asu.edu/~dugger/student2019/KStarK-DNP-10-14-19.pdf>
- [37] Sumner, B., *Search for excited  $\Xi^*$  states and preliminary cross section for  $\Xi^-(1530)$*  (presentation at the American Physical Society April Meeting, 2021),  
URL: <http://meson.hldsite.com/presentations/Sumner/APSSummerApril2021.pdf>
- [38] CLAS Collaboration, *JLAB Experiment CLAS Database*,  
URL: <http://clasweb.jlab.org/physicsdb/intro.html>
- [39] Institute for Nuclear Studies Data Analysis Center, *SAID Partial-Wave Analysis Facility*,  
URL: <http://gwdac.phys.gwu.edu/>
- [40] Jefferson Lab Data Acquisition Group, *EVIO Users' Guide*,  
URL: [ftp://ftp.jlab.org/pub/coda/evio/2.0/evio\\_Users\\_Guide.pdf](ftp://ftp.jlab.org/pub/coda/evio/2.0/evio_Users_Guide.pdf)

## B Data management plan

The ASU Meson Physics Group, as a member of the CLAS Collaboration and the GlueX Collaboration, adheres to the data management practices of those groups, which are consistent with best practices in the field. As is common in experimental hadronic physics, the data obtained from experiments pass through three stages: raw data, calibrated (or “cooked”) data, and final results. Data in the first two stages are kept in the storage facilities at Jefferson Lab, where those data can be accessed and utilized by institutions, like ASU, that are in the particular collaboration within which the data were taken. As analyses proceed to the results stage, preliminary results are disseminated in talks and presentations. With final collaboration approval, the results are published in refereed journals and placed in collaboration archives for public access.

**Expected data:** Raw and cooked data are stored physically at JLab. Those JLab storage resources are multiply redundant in order to prevent any data loss. As is the case



for other groups, the ASU Meson Physics Group makes copies of portions (or, in some cases, the entirety) of the cooked data for a given running period temporarily using hard drives on computer resources local to the group; that temporary storage also is usually on redundant devices. Thus, at any point in the raw and cooked stages, a given set of data may exist on many other sites than JLab, so preservation is robust. There generally is no attempt by a local group to permanently store cooked data on local resources. In case of local hardware failures or human error leading to the loss of data on local resources, those data are re-copied onto local hardware from the original copies at JLab. Once final results are published, those results are placed on archives accessible to the general public (e.g. Refs. [38, 39]).

**Data format:** The data format for raw and cooked data for the GlueX and CLAS collaborations, called EVIO, was developed by JLab; documentation describing the EVIO format is available in Ref. [40].

**Access and data sharing:** Raw and cooked data are accessible to members of each collaboration. A person or institution desiring access to the raw and cooked data must apply and be accepted for membership within the CLAS or GlueX collaborations. The final data products of the ASU Meson Physics Group, consisting primarily of cross sections and spin observables, are made publicly available through publications, talks, and presentations, as well as in databases such as the SAID database [39] and CLAS Archive [38].

**Policies for re-use and re-distribution:** Preliminary results often are presented at open national and international scientific conferences. These preliminary results are internally reviewed within the respective collaboration prior to presentation, with permission obtained to present the preliminary results required by the collaboration prior to the presentation. Such preliminary results are useful in the the initial development of physical interpretations, and comparison with other world data. Reproduction of preliminary results is not permitted without explicit permission of the respective collaborations. Once results have been through the full internal review process within each collaboration, the results are deemed “final”. The data products are submitted to professional journals and made available in public databases such as the SAID database [39] and the CLAS Archive [38].

**Archiving of data:** As noted above, the raw and cooked data for data runs are archived on tape on-site at JLab. Final results are archived in databases such as the SAID database [39] and the CLAS Archive [38].

## C Principal collaborators

### C.1 Close collaborators

**Hall B/CLAS/CLAS12:** B. Briscoe (George Washington University), V. Burkert (JLab), V. Crede (Florida State University), L. Elouadrhiri (JLab), D. Glazier (University of Glasgow), L. Guo (Florida International University), K. Hicks (Ohio University), F. Klein (George Washington University), K. Livingston (University of Glasgow), E. Pasyuk (JLab), J. Price (CSU Dominguez Hills), D. Sober (CUA), I. Strakovsky (George Washington University) S. Strauch (University of South Carolina). N. Zachariou (University of York)

**Hall D/GlueX:** E. Chudakov (JLab), S. Dobbs (Florida State University), P. Eugenio (Florida State University), R. Jones (University of Connecticut), D. Lawrence (JLab), C.A. Meyer (Carnegie Mellon University), M. Shepherd (Indiana University), E. Smith (JLab), J. Stevens (College of William and Mary), S. Taylor (JLab).

## C.2 Advisors and postdoctoral sponsors of the primary investigator

B.G. Ritchie (ASU).

## C.3 Former post-doctoral participants in academic and lab positions

No former post-doctoral participants.

## C.4 Former Ph.D. students in academic and lab positions

Only a single former Ph.D. student (S. Cole) that is newly graduated and looking for suitable employment.

# D Publications

Table 5: Summary of Publications. Past members of the work effort are marked with an asterisk(\*).

Name	Letter Publications	Other Refereed Journals	Invited Talks
Faculty/Permanent Staff			
M. Dugger	5	8	
Term and Other Staff			
S. Cole (*)	1	4	
B. Sumner		2	
A. Gardner			
Total	5	8	0

## E Biographical sketches

### E.1 Michael R. Dugger

#### Professional preparation

	<u>Institution</u>	<u>Major/Conc.</u>	<u>Degree, Year</u>
Undergraduate:	Northern Arizona State University	Physics/Mathematics	B.S., 1993
Graduate:	Arizona State University	Physics	Ph.D., 2001
Postdoctoral:	Arizona State University	Physics	2002-2006

#### Appointments

Associate Professor (tenure-track)	Arizona State University	2017 to present
Associate Research Professor	Arizona State University	2013 to 2017
Assistant Research Professor	Arizona State University	2006-2013
Postdoctoral Research Associate	Arizona State University	2002-2006

#### Synergistic activities

GlueX Collaboration Board member, 2013-2015; Division of Nuclear Physics, Conference Experience for Undergraduates, Review Committee member, 2018; International Advisory Committee, MENU Conference, 2018-Present;

#### Publications over the last three years

1. N. Zachariou *et al.*, *Double polarisation observable  $G$  for single pion photoproduction from the proton*, Phys. Lett. B **817** (2021), p. 136304
2. U. Shrestha *et al.*, *Differential cross sections for  $\Lambda(1520)$  using photoproduction at CLAS*, Phys. Rev. C **103** (2021) (2), p. 025206
3. T. B. Hayward *et al.*, *Observation of Beam Spin Asymmetries in the Process  $ep \rightarrow e' \pi^+ \pi^- X$  with CLAS12*, Phys. Rev. Lett. **126** (2021), p. 152501
4. M. Carver *et al.*, *Photoproduction of the  $f_2(1270)$  meson using the CLAS detector*, Phys. Rev. Lett. **126** (2021) (8), p. 082002
5. S. Adhikari *et al.*, *Measurement of beam asymmetry for  $\pi^- \Delta^{++}$  photoproduction on the proton at  $E_\gamma = 8.5$  GeV*, Phys. Rev. C **103** (2021), p. L022201, URL: <https://link.aps.org/doi/10.1103/PhysRevC.103.L022201>
6. T. Hu *et al.*, *Photoproduction of  $\eta$  mesons off the proton for  $1.2 < E_\gamma < 4.7$  GeV using CLAS at Jefferson Laboratory*, Phys. Rev. C **102** (2020) (6), p. 065203
7. S. Adhikari *et al.*, *The GlueX beamline and detector*, Nuclear Instruments and Methods in Physics Research Section A: Accelerators, Spectrometers, Detectors and Associated Equipment **987** (2021), p. 164807, URL: <https://www.sciencedirect.com/science/article/pii/S0168900220312043>
8. A. Celentano *et al.*, *First measurement of direct photoproduction of the  $a_2(1320)^0$  meson on the proton*, Phys. Rev. C **102** (2020) (3), p. 032201

9. S. Adhikari *et al.*, *Measurement of the photon beam asymmetry in  $\vec{\gamma}p \rightarrow K^+\Sigma^0$  at  $E_\gamma = 8.5$  GeV*, Phys. Rev. C **101** (2020), p. 065206,  
URL: <https://link.aps.org/doi/10.1103/PhysRevC.101.065206>
10. A. Schmidt *et al.*, *Probing the core of the strong nuclear interaction*, Nature **578** (2020) (7796), pp. 540–544
11. S. Adhikari *et al.*, *Beam asymmetry  $\Sigma$  for the photoproduction of  $\eta$  and  $\eta'$  mesons at  $E_\gamma = 8.8$  GeV*, Phys. Rev. C **100** (2019), p. 052201,  
URL: <https://link.aps.org/doi/10.1103/PhysRevC.100.052201>
12. A. Ali *et al.*, *First Measurement of Near-Threshold  $J/\psi$  Exclusive Photoproduction off the Proton*, Phys. Rev. Lett. **123** (2019), p. 072001,  
URL: <https://link.aps.org/doi/10.1103/PhysRevLett.123.072001>
13. P. Roy *et al.*, *First Measurements of the Double-Polarization Observables  $F$ ,  $P$ , and  $H$  in  $\omega$  Photoproduction off Transversely Polarized Protons in the  $N^*$  Resonance Region*, Phys. Rev. Lett. **122** (2019) (16), p. 162301
14. J. T. Goetz *et al.*, *Study of  $\Xi^*$  Photoproduction from Threshold to  $W = 3.3$  GeV*, Phys. Rev. C **98** (2018) (6), p. 062201
15. S. Lombardo *et al.*, *Photoproduction of  $K^+K^-$  meson pairs on the proton*, Phys. Rev. D **98** (2018) (5), p. 052009

## F Student tracking information

Table 6: Student tracking information

Student	Date Entered Graduate School	Date Joined Group	Degree Program	Date Degree Awarded / (Expected)	Advisor
Sebastian Cole	August 2015	August 2016	Ph.D.	July 2021	M. Dugger
Brandon Sumner	August 2017	May 2019	Ph.D.	(May 2022)	M. Dugger
Alan Gardner	August 2020	January 2021	Ph.D.	(May 2025)	M. Dugger

## G Current and pending support

The PI is currently supported by the DOE on the current grant. No carryover is expected from the current grant to the renewed grant being proposed in this document. Beyond the current renewal-proposal, the PI has no other pending support.

## H Facilities and resources

### H.1 Laboratory facilities

Sufficient lab space for small equipment assembly, fabrication of computer systems, and detector testing has been committed to the ASU Meson Physics Group by ASU within the College of Integrated Sciences and Arts (CISA) on the Polytechnic campus. A laboratory space of approximately 500 square feet in size has been committed to the group, and contain cluster computers that were built by the group. The lab space also include electronic test benches, as well as workstations for those group personal that are on site at ASU. As needed, on-site fabrication and assembly of instrumentation at JLab can also take place in areas provided by JLab for that work.

### H.2 Computer facilities

The ASU Meson Physics Group has built cluster computers for data analysis and Monte Carlo simulations. The initial reduction and calibration of data taken at JLab is performed on a computer farm provided by that laboratory, and ASU group members are provided full access to those facilities.

### H.3 Office space

At ASU sufficient office space is provided for the PI and ASU Meson Physics Group members. For those members of the group located on-site at JLab, office space has been allocated by JLab sufficient for our group.

## **H.4 Major instrumentation**

Unique and specialized instrumentation are required for performing the research of the ASU Meson Physics Group described in Section 2 of this proposal. Working with collaborators from other institutions, this equipment has been designed and constructed within the experimental halls at Jefferson Lab, specifically Hall B and Hall D. Both halls will provide polarized tagged photon beams, the cryogenic targets, and the associated detector systems which will enable the experiments described.